

# RENAULT MEGANE



1st December 2021

**the essentials**



**hatch and  
sport tourer  
versions**



**plug-in Hybrid  
engine**

**4 driving  
assistance  
systems**

**boot volume  
of up to 308 l  
on hatch**

**boot volume  
of up to 447 l  
on sport tourer**



MEGANE

## iconic design

Combine refinement and modernity with Megane. Its dynamic lines are backlit with the emblematic C-shaped brand light. The radiator and chrome grille are complemented by a redesigned front bumper. With its muscular shoulders, the Sport Tourer version displays a high-status design.





**interior quality**



1

1. 9.3" easy link multimedia screen and 10.2" digital instrument panel

The interior equipment combines elegance and the latest technology. High-quality materials and comfort combine to offer a contemporary feel. The 9.3" easy link multimedia screen and 10.2" configurable digital instrument panel with navigation replication connect you to a world of emotions.



MEGANE



# sportiness embodied

The Megane R.S. line version exudes sportiness. F1® blade built into the honeycomb bumper, 17" Monthlery diamond cut alloy wheels, two exhaust pipes and aerodynamic spoiler reinforce the ultra-dynamic style of the bodywork with the R.S. line badge. Inside, discover the distinctive marks of a real sports car: perforated leather sport steering wheel with double diamond R.S., brushed aluminium competition-type pedal unit, reinforced support seats with Alcantara upholstery.





**new perspectives**



The E-Tech plug-in hybrid technology is straight out of F1® and combines two electric engines and one 1.6 l petrol engine. This new concept marries the versatility of the hybrid with the driving pleasure of the electric thanks to its new and innovative multi-mode clutch-free gearbox. In electric mode, you have up to 30 miles of driving range<sup>(1)</sup> and reduce fuel consumption and CO<sub>2</sub> emissions by up to 70% compared to those of an equivalent combustion-engine vehicle. With silent and lively starting, regenerative braking and deceleration and unrivalled driving flexibility, you will also discover new sensations behind the wheel. Easy to drive, Renault Megane E-Tech plug-in hybrid can be connected to a charging point or domestic socket<sup>(1)</sup> using the readily available charging cable stored in a dedicated boot space.

(1) Charge your battery in just 3 hours using a 16 A socket (Wallbox or public charging point).



1. remote charging control via My Renault application
2. multi-sense technology on 9.3" central screen: 100% Pure electric mode

## advanced technology

The multi-sense technology enables you to choose between the different driving modes: 100% Pure electric mode, or My Sense and Sport modes, which combine electric and combustion engine use, with a livelier and more exciting drive in Sport mode. With the E-Nav function that can be activated in My Sense mode, you can use the electric motor at the most appropriate moments of your journeys once the navigation system has been programmed. In this way, you save up to 10% on fuel consumption and optimise the battery discharge. You can also control vehicle charging remotely and enjoy various connected services with the My Renault application.





1. smartphone replication via Android Auto™ or Apple CarPlay™
2. 3D navigation interface with Google address search
3. multi-screen interface: driving assistance, multi-sense and customisable widgets



**connected to your  
everyday life**



3

The Renault multi-sense system offers you a personalised driving experience. A choice of 8 lighting moods and 4 modes are available. The R-Sound app lets you configure your musical and sound surroundings. With easy link - compatible with Android Auto™ or Apple CarPlay™ - and its connected navigation system that is replicated on the 10.2" digital instrument panel, send your destination to your vehicle from your smartphone so that it can offer you the best door-to-door journey options. My Renault also suggests the best route for the last few metres on foot and helps you find your parked car.

Android Auto™ is a trademark of Google Inc.  
Apple CarPlay™ is a trademark of Apple Inc.

1. up to 308 litres of boot volume on hatch and 447 litres on sport tourer

## modular layout and comfort





# 4 driving assistance systems

Renault Megane is equipped with multiple assistance systems driving innovations, selected from below. Resolutely safe, it promises you a safe journey.

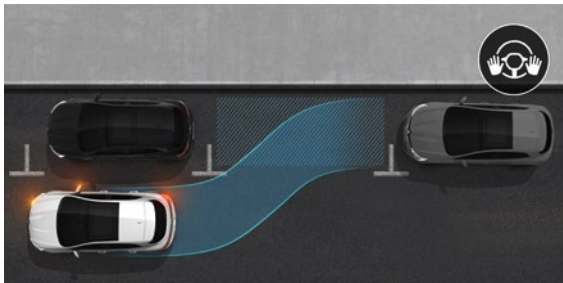

## hands-free parking (exclusive to R.S. Line)

This system makes it easier to park. Your vehicle handles both finding a parking spot and steering. All you need to manage is the speed.

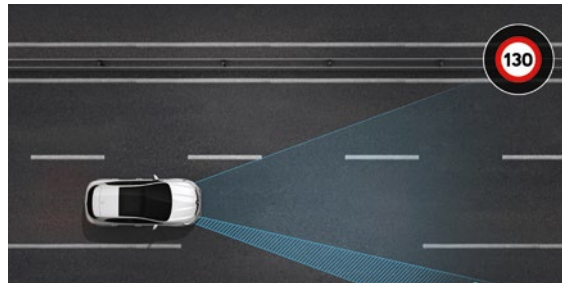

## traffic sign recognition

This system informs you of speed limits via the instrument panel and alerts you if you exceed the speed limit thanks to a camera positioned at the top of the windscreen.



## advanced emergency braking system

This system detects vehicles to the side or in front, and stops the vehicle in the event of any danger. Driving in the city has never been so safe, day or night.

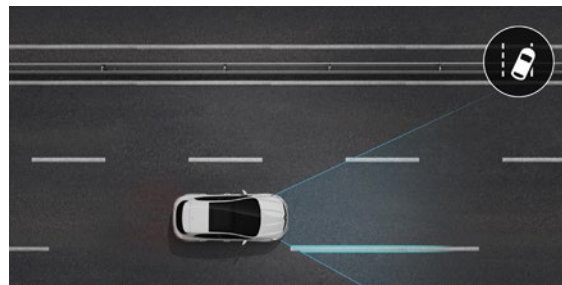

## lane departure warning

The system informs the driver of unintended crossings of a solid or broken line, using a camera located on the windscreen, behind the rear-view mirror.



RENAULT

MEGANE

# colour palette



Glacier White



Artic White (MP)



Iron Blue (MP)



Flame Red (MP)



Highland Grey (MP)



Titanium Grey (MP)



Diamond Black (MP)

MP: metallic paint.

# Megane Hatch & Sport Tourer



## Iconic

### standard

#### safety essentials

- rear parking sensors
- airbags - curtain front and rear
- front lateral airbags
- front passenger's two stage adaptive airbag
- ESP (Electronic Stability Programme) with ASR (Anti-Skid Regulation) and UCL (understeer logic control)
- tyre inflation kit
- cruise control with speed limiter
- tyre pressure monitor

#### driving

- ABS with EBD (Electronic Brake Distribution) and Emergency Brake Assist
- electronic parking brake
- hill start assist
- ECO driving mode

#### comfort

- steering wheel - rake and reach adjustable
- sun visor with mirror with light
- integrated fuel filler cap
- leather steering wheel
- height-adjustable headrests front and rear
- electric front and rear windows
- heated, electrically adjustable door mirrors

#### exterior design

- body coloured door mirrors
- 16" Impulse diamond cut alloy wheels
- pure vision front LED headlights
- signature C-shaped LED daytime running lights
- dynamic rear indicators

#### interior design

- driver and front passenger reading lights
- keycard - hands free
- 10" digital instrument display panel
- illuminated luggage compartment (on opening of boot)

#### multimedia

- 2x USB slots at the rear
- 4 X 35W speakers with 3D sound
- 7" EASY LINK touchscreen with navigation: 4x20W amplifier +FM DAB double tuner, sound auditorium, 2x USB, 1x Jack / Bluetooth, smartphone integration plus: Apple Carplay/ Android Auto
- fingertip audio system remote control

\* Only on Megane Estate.

Android Auto™ is a trademark of Google Inc.

Apple CarPlay™ is a trademark of Apple Inc..



## R.S. line

### standard

#### exterior design

- 17" Monthlery diamond cut alloy wheels
- front body coloured R.S. Line bumper
- rear body coloured R.S. Line bumper

#### interior design

- R.S. Line black fabric upholstery with red stitching
- R.S. badging
- R.S. Line dashboard and trim
- chrome door sill plates - R.S. Line
- R.S. leather steering wheel

#### driving equipment

- Advanced Emergency Braking System (AEBS)
- rear parking camera
- hands free parking

#### multimedia

- 9.3" EASY LINK touchscreen with Navigation: 4x20W amplifier +FM DAB double tuner, sound auditorium, 2xUSB, 1x jack / Bluetooth, smartphone integration plus: Apple Carplay/ Android Auto<sup>1</sup>

<sup>1</sup> except on E-Tech versions. <sup>2</sup> please contact your sales advisor for more details on the materials used. All seats mentioned as being leather in this document are composed of real leather and coated textile. Android Auto™ is a trademark of Google Inc. Apple CarPlay™ is a trademark of Apple Inc.

# upholstery



Iconic black cloth upholstery



R.S. Line black fabric upholstery with red stitching

# wheel rims



16" Impulse alloy wheel<sup>(2)</sup>



17" Montlhéry wheel rim<sup>(3)</sup>

\*all seats mentioned as being leather in this document are composed of real leather and coated textile. Please contact your sales advisor for more details on the materials used. <sup>(1)</sup> available on Zen version. <sup>(2)</sup> available on Intens version. <sup>(3)</sup> available on R.S. line version.

# equipment and options

	Hatch Iconic	Hatch R.S. Line	Sport Tourer Iconic	Sport Tourer R.S. Line
<b>Driving and Safety</b>				
ABS with EBD (Electronic Brake Distribution) and Emergency Brake Assist	■	■	■	■
Electronic parking brake	■	■	■	■
Advanced Emergency Braking System (AEBS)	-	■	-	■
Hill Start Assist	■	■	■	■
Eco mode	■	■	■	■
Gear shift indicator	■	■	■	■
Airbags - Curtain front and rear	■	■	■	■
Airbags - Deactivation of front passenger (for use with child seats)	■	■	■	■
Airbags - Front lateral	■	■	■	■
Airbags - Front passenger's two stage adaptive airbag	■	■	■	■
Indicators with side repetitions	■	■	■	■
Automatic headlights and windscreen wipers	■	■	■	■
Cruise control with speed limiter	■	■	■	■
ESP (Electronic Stability Programme) with ASR (Anti-Skid Regulation) and UCL (understeer logic control)	■	■	■	■
Visio System (lane departure warning, traffic sign recognition, automatic high/low beam)	■	■	■	■
Front Fog lights	■	■	■	■
Front and rear towing rings	■	■	■	■
Signature C-shaped LED daytime running lights	■	■	■	■
Full LED headlights	■	■	■	■
ISOFIX child seat anchorage points on rear outer seats	■	■	■	■
Power assisted steering	■	■	■	■
Front and Rear Parking sensors	■	■	■	■
Rear parking camera	■	■	-	■
Hands free parking	-	■	-	■
Seats - height adjustable front seatbelts with double pretensioners	■	■	■	■
Side impact protection bars	■	■	■	■
Tyre Inflation Kit	■	■	■	■
Tyre Pressure Monitor	■	■	■	■
<b>Exterior design</b>				
16" IMPULSE diamond cut alloy wheels	■	-	■	-
17" MONTHLERY diamond cut alloy wheels	-	■	-	■
Door mirrors - Body coloured shell	■	■	■	■
Door mirrors - Electrically adjustable, heated and folding	■	■	■	■
Front body coloured R.S.Line bumper	-	■	-	■
Rear body coloured R.S. Line bumper	-	■	-	■
<b>Interior design</b>				
Heated rear screen	■	■	■	■
Electric front windows	■	■	■	■
Electric rear windows	■	■	■	■
Windows - extra tinted rear and tailgate with heating function	■	■	■	■
ICONIC Black cloth upholstery	■	-	■	-
R.S. Line Black fabric upholstery with red stitching	-	■	-	■
R.S. Badging	-	■	-	■
Height adjustable drive seat	■	■	■	■
Fully adjustable front headrests	■	■	■	■
Height adjustable front seat belts	■	■	■	■
3 height adjustable rear head restraints	■	■	■	■
Front centre armrest with storage	■	■	■	■
Glovebox	■	■	■	■
Trip computer	■	■	■	■
Rev-counter	■	■	■	■
10.2" TFT driver information display	■	■	■	■
EV mode button	■	■	■	■

# equipment and options

	Hatch Iconic	Hatch R.S. Line	Sport Tourer Iconic	Sport Tourer R.S. Line
Adjustable dashboard illumination	■	■	■	■
Low fuel level warning light	■	■	■	■
Oil level gauge	■	■	■	■
Exterior temperature indicator	■	■	■	■
Rear seat belt undone audible alert	■	■	■	■
Driver and passenger seat belt undone warning audible alert	■	■	■	■
Door / Boot open warning light	■	■	■	■
Framless rear-view mirror	■	■	■	■
Auto-dimming rear-view mirror	■	■	■	■
R.S. Line Dashboard and Trim	-	■	-	■
Door handles - body coloured	■	■	■	■
Hands free keycard	■	■	■	■
Chrome door sill plates - 'R.S. Line'	-	■	-	■
Air recirculation facility	■	■	■	■
Automatic Dual Zone climate control	■	■	■	■
Heating ducts to the feet of the rear passengers	■	■	■	■
MULTI-SENSE: 3 driving modes and 8 ambient lighting colours	■	■	■	■
Driver and front passenger reading lights	■	■	■	■
Rear courtesy lights	■	■	■	■
Illuminated luggage compartment (on opening of boot)	■	■	■	■
<b>Comfort</b>				
Integrated fuel filler cap	■	■	■	■
Leather steering wheel	■	-	■	-
R.S. Leather steering wheel	-	■	-	■
Sun visor with mirror with light	■	■	■	■
<b>Multimedia</b>				
Fingertip audio system remote control	■	■	■	■
2x USB Slots at the rear	■	■	■	■
4 X 35W speakers with 3D sound	■	■	■	■
7" EASY LINK touchscreen with Navigation: 4x20W amplifier +FM DAB double tuner, sound auditorium, 2xUSB, 1 x Jack / Bluetooth, smartphone integration plus: Apple Carplay/ Android Auto	■	-	■	-
9.3" EASY LINK touchscreen with Navigation: 4x20W amplifier +FM DAB double tuner, sound auditorium, 2xUSB, 1x Jack / Bluetooth, smartphone integration plus: Apple Carplay/ Android Auto	-	■	-	■

■: standard. □: optional. -: unavailable.



# key information

for Prices, please refer to the Renault Car Price Guide available at your local dealer and on [www.renault.co.uk](http://www.renault.co.uk)

<b>hatch versions</b>	<b>WLTP CO<sub>2</sub> combined (g/km)*</b>	<b>Combined fuel consumption (mpg)*</b>	<b>BHP</b>	<b>Benefit in Kind* (2021/2022)</b>	<b>Insurance group</b>
Iconic E-TECH Plug-in Hybrid 160 Auto	28	235.4	160	11%	21
R.S.Line E-TECH Plug-in Hybrid 160 Auto	28	235.4	160	11%	22

## **sport tourer versions**

Iconic E-TECH Plug-in Hybrid 160 Auto	30	217.3	160	11%	22
R.S. Line E-TECH Plug-in Hybrid 160 Auto	29	217.3	160	11%	22

\*WLTP figures shown are for comparability purposes. Actual real world driving results may vary depending on factors such as weather conditions, driving styles, vehicle load or any accessories fitted after registration. †Renault UK Limited does not offer tax advice and recommends that all Company Car Drivers consult their own accountant with regards to their particular tax position. Benefit in kind figures from 1st April 2021. Model availability correct at time of publishing. For further information regarding vehicle availability please consult with dealer.

<b>options</b>	<b>Hatch Iconic</b>	<b>Hatch R.S. Line</b>	<b>Sport Tourer Iconic</b>	<b>Sport Tourer R.S. Line</b>	<b>Prices (Inc Vat)</b>
Non Metallic Paint: Glacier White	●	●	●	●	FOC
Metallic Paint: Arctic White, Highland Grey, Titanium Grey, Diamond Black	○	○	○	○	£650
Renault i.d Metallic Paint: Iron Blue, Flame Red	○	○	○	○	£750

●=Standard; ○=Optional; - = Not available; FOC = Free of charge option ^Manufacturer's Recommended Retail Price

# accessories

1. **Roof bars and locker.** Enjoy additional space by equipping your All-New Megane with QuickFix roof bars. They are easy to fit to accommodate ski racks, bicycle racks or even one of our roof lockers.



**2. Retractable towbar with tilting bicycle rack.** Take your mountain bikes on a weekend getaway or tow a trailer, thanks to the retractable towbar. The rest of the time, the design of your All-New Megane is preserved as you can hide it under the rear bumper.

**3. Induction charger.** No matter how long your journey, stay connected with the integrated induction smartphone charger.

**4. Adaptable EasyFlex protection.** This non-slip and waterproof system is essential for protecting your vehicle's boot and carrying bulky or dirty loads. It folds and unfolds very easily, adapting to the position of the rear seats.

**5. Protective film.** Protect your vehicle against everyday nicks thanks to transparent protection film. Minor dents, scratches or even repeated friction are no longer an issue.

some accessories require the vehicle to be registered before fitment. Your local dealer will be able to offer further advice and supply a dealer fitted price for vehicles already in dealer stock. Accessories are fitted post production and may have an impact on real world fuel (actual) consumption and CO<sub>2</sub> figures.

for more information, consult the Megane accessories brochure.



# engines

	Hatch E-Tech Plug-in Hybrid 160 Auto	Sport Tourer E-Tech Plug-in Hybrid 160 Auto
Engine type	plug-in hybrid	plug-in hybrid
Fuel	unleaded Fuel (E10) & Electric	unleaded Fuel (E10) & Electric
Maximum power kW (hp)/revs (rpm)	116 kW combined (160 hp)	116 kW combined (160 hp)
Maximum power - kw ISO	petrol engine: 69 electric motor: 49"	petrol engine: 67 electric motor: 49"
Maximum Torque (rpm)	petrol engine: 5600 electric motor: 2283"	petrol engine: 3200 electric motor: 2283"
Gearbox	automatic hybrid	automatic hybrid
Fuel Type	petrol hybrid (PHEV)	petrol hybrid (PHEV)
<b>Batteries</b>		
Battery type	lithium ion	lithium ion
Voltage (V)	346V	240/403V
Capacity (kWh)	9.8	9.3
<b>Charging time (0-100 %)</b>		
2.3kW domestic socket	5 Hours	5 Hours
3.7kW domestic socket	3 Hours	3 Hours
3.7kW/7.4KW Wallbox	3 Hours	3 Hours
<b>Performance</b>		
0- 62 mph - secs (0-100 km/h)	9.4	9.8
Maximum Speed mph (km/h)	108.7 (175)	114(175)
Standing 1000m in seconds	30.9	30.9
<b>Electric-only range (WLTP)</b>		
Combined cycle	up to 30 miles	up to 30 miles
<b>Certification</b>		
Protocol	WLTP	WLTP
Emissions conformance	Euro 6 D Full	Euro 6 D Full
<b>Fuel consumption and emissions</b>		
Combined cycle - mpg	235.4	217.3
Combined cycle - l/100 km	1.2	1.3
CO <sub>2</sub> (g/km)	28	29-30
<b>Volumes and weights</b>		
Fuel Tank (L)	39	217.3
Kerb Weight (kg)	1530-1599	1603-1669
Maximum Permissable laden weight (MPLW) (kg)	2060	1669
Gross train weight (GTW) (kg)	2810	2881
Max. braked/unbraked towing weight (kg)	750	750

# dimensions & volumes

## Hatch

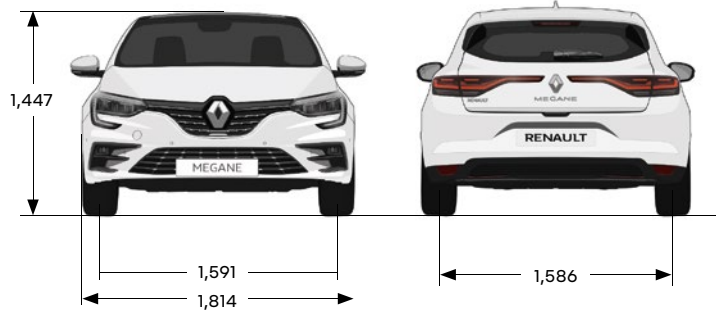
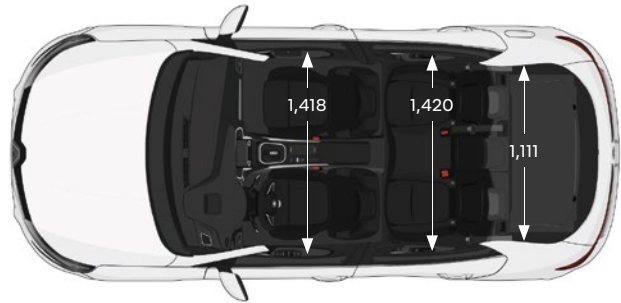
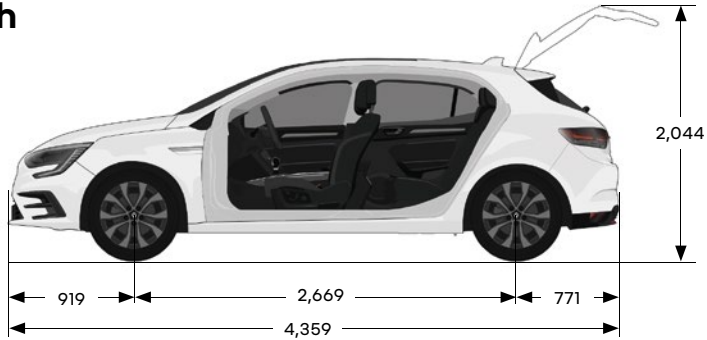

## Sport Tourer

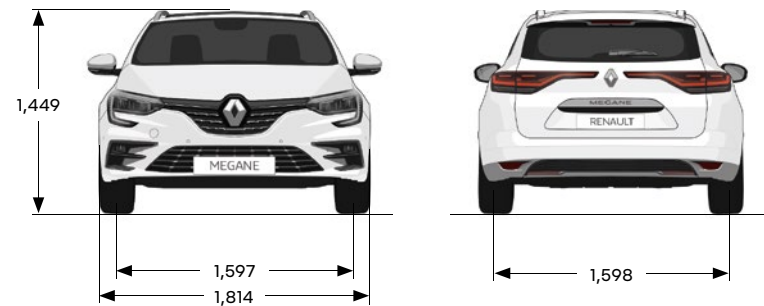
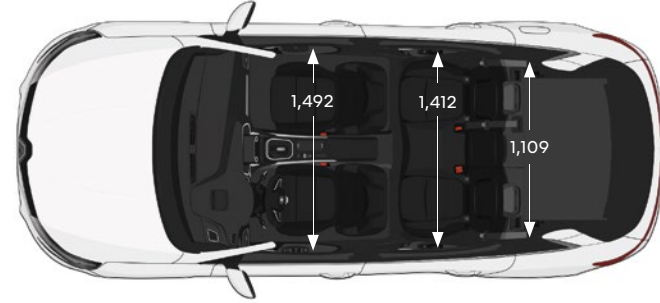
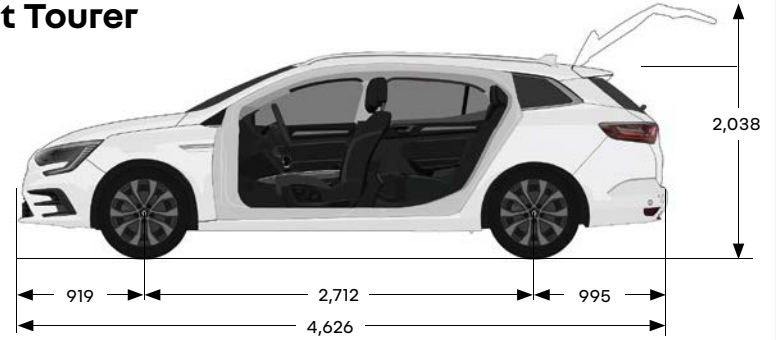

### Boot volume - VDA standard (litres)

	Hatch	Sport Tourer
Boot volume	308	447
Maximum boot volume (bench seat folded down)	1202	1408

# Renault care service

We are always at your side to make life easier and save you time with the maintenance of your Renault: online quotes and appointments, fixed price packages, maintenance contracts, insurance and assistance, personalised My Renault programme, etc. Take advantage of our simple, fast solutions tailored to your needs.

## **your first steps**

All the information you need can be found :

- on our websites, product/service/financing offers, test drive appointments, etc.
- in our dealership network, meetings with our sales and technical teams.

## **Renault care service, 100 % covered**

Guard against the unexpected with Renault extended warranties, insurance policies and assistance, which are always there for you.

## **My Renault, day-to-day partner**

Enjoy the benefits of a personalised web account, especially for advice, offers, exclusive perks, maintenance programme reminders, your upcoming appointments, etc.

## **Renault care service, worry-free maintenance**

Our Renault care service maintenance contracts and fixed price packages offer you the benefits of a bespoke all-inclusive package.

## **accessories, your custom Renault**

Our range of accessories contains everything you need to make your vehicle even more attractive, practical, comfortable and customised.

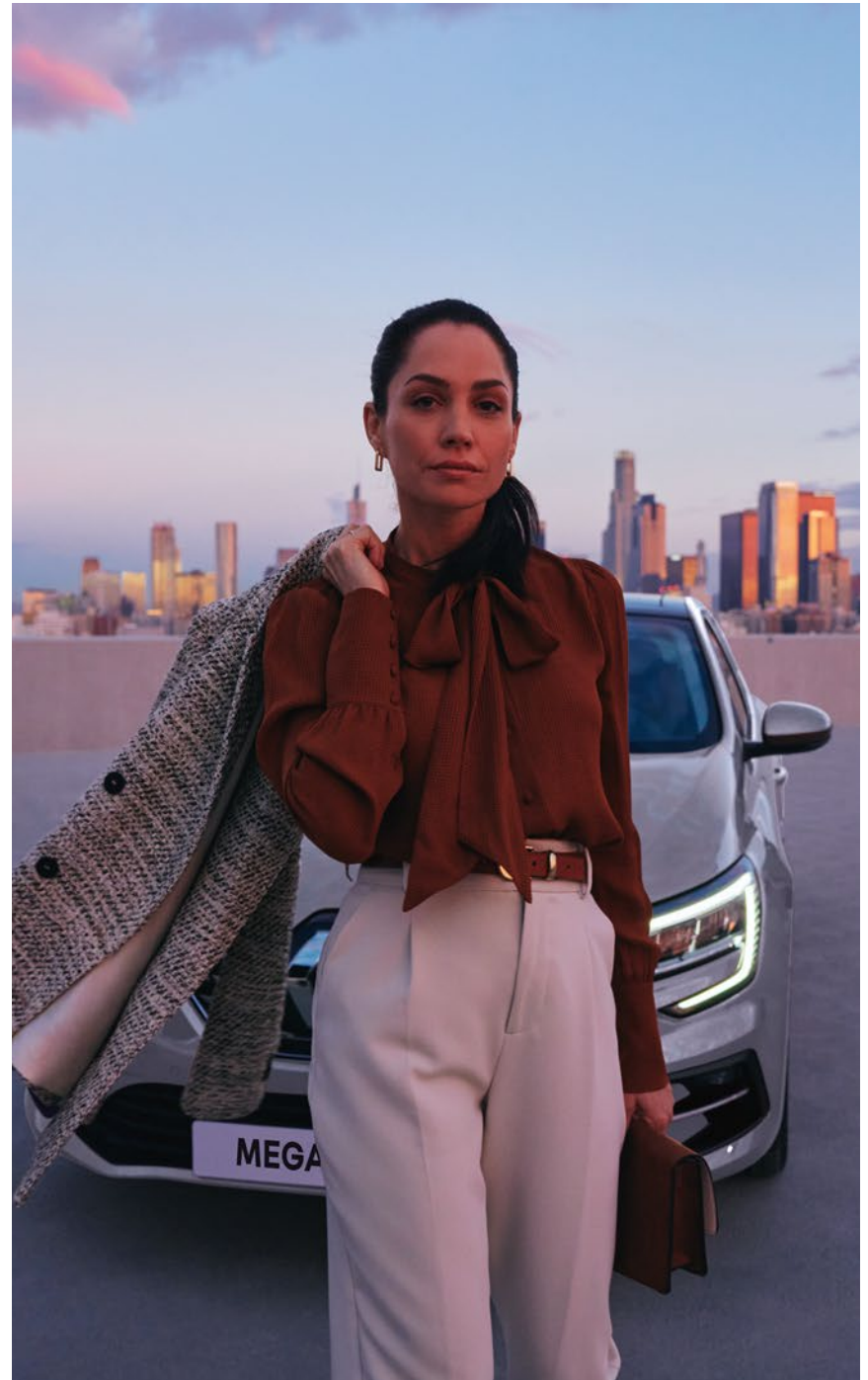

# Megane the icon

**25 years of exacting standards**



The first mass-produced Megane entered dealerships during the summer of 1995. The chassis and engines were modelled after the technical framework inaugurated with the Renault 19 a few years earlier. To these technologies, which have been tried, tested and improved over time, engineers have added a new requirement in terms of perceived quality.

But it is above all in terms of bodywork choices that the new arrival innovates. Alongside the traditional 5-door compact saloon, Megane comes in five versions: Megane Classic with a large boot; Megane Estate for family weekends; Megane Coupé for sporty driving; Megane Cabriolet to replace the Renault 19 Cabriolet; and Megane Scenic, the first compact passenger van that can accommodate five people with bags and luggage in a spacious, modern and modular passenger compartment.



“Very compact profile, beak grille, rear door cut-out outlining a perfect curve, Megane is undoubtedly the most elegant and most successful version of its generation, aesthetically speaking”, proclaimed the Auto Moto magazine car tester in December 1995 when describing the 5-door Patrick Le Quément version.

**→ four generations since 1995**

The first Megane would be produced from 1995 to 2002. In 2002, a second version broke away from the design of the first version. The third generation would appear at the 2008 Paris Motor Show. As for the fourth, you only need flip through the pages of this brochure to understand that Megane has never been so trendy, with new shapes and equipment worthy of top-of-the-range saloons.



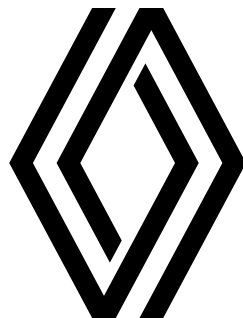



## configure and order your Renault Megane on [www.renault.com](http://www.renault.com)

Every precaution was taken to ensure this publication was accurate and up-to-date when printed. this document was created using pre-production and prototype models. in line with its policy of continuous product improvement, renault reserves the right to change the specifications, vehicles and accessories described and featured at any time. any such changes are communicated to renault dealers as quickly as possible. depending on the country of sale, some versions may differ and some equipment may not be available (as standard, as an option or as an accessory). please contact your nearest dealer for the latest information. for technical printing reasons, the colours featured in this document may differ slightly from those of the actual paintwork or interior trim. all rights reserved. reproduction in any format and by any means of all or part of this publication is prohibited without prior written authorisation from renault.

Publicis - Photo credits: J. Ludes, Bandits, Additive, D. Hill, Wanda, A. Bernier, Maground, © Renault Design © Renault Marketing 3D-Commerce, RCD, Pagécran - online only - December 2021.

Renault s.a.s. French simplified joint-stock company with capital of €533,941,113.00 / 13-15, quai Le Gallo - 92100 Boulogne-Billancourt Cedex - Nanterre Trade & Companies Registry B 780 129 987 / Tel.: 0806 00 20 20.

Renault recommends  Castrol

   [renault.com](http://renault.com)